



Bright Presentations in Meeting Rooms and Classrooms

- From 4000 to 4200AL Brightness and exceptional 11000:1 contrast ratio
- x1.3 zoom ratio
- H/V keystone and corner fit to adapt to any integration constraint
- Large choice of input connections (HDMI, MHL connectivity, VGA IN/OUT,...)
- 3D ready
- LAN control/LAN display
- Dust filter free design
- Energy saving: SmartEco, auto power off, Eco blank, 0.5W standby power consumption*
- Lamp life time up to 6000 hours**
- 10W speaker with powerful sound

*Network off

**In smart eco mode



HDMI
HIGH DEFINITION MULTIMEDIA INTERFACE



Extron



MX726 4000AL XGA DLP Projector
MW727 4200AL WXGA DLP Projector

BenQ

Because it matters

Exceptional Image Quality for High-Impact Presentations

Superior Image Quality

With up to 4200 ANSI Lumens, the MX726/MW727 will always give you the best clarity under bright environment conditions. So, take advantage! Stay in control and enjoy perfect presentations and the best interactions with your audience; moreover, the combined expertise of BenQ's projector know-hows delivers an outstanding 11000:1 contrast ratio at the highest to significantly improve the black level for superbly rendered image definition.



High Contrast

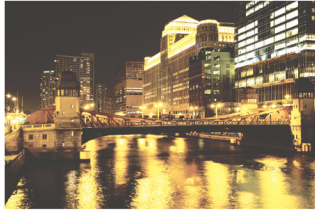

Low Contrast

Long-Lasting DLP Image Perfection

Utilizing a nearly-sealed DLP projection engine, BenQ projectors exhibit virtually no image distortion from panel aging due to heat or dust buildup. Millions of micro mirrors on the advanced DMD chip reflect pure light through the color wheel, producing precise details and intensely saturated colors without degradation over time.



MHL connectivity & LAN control/display

MHL Connectivity

With MHL connectivity, you can share your content from your Android devices on big screen. MX726/MW727 features MHL function and allows you to mirror the data, photo and other contents from your android devices to big screen, Also, your device is being charged while you're using it, you don't have to worry about the power while presenting.

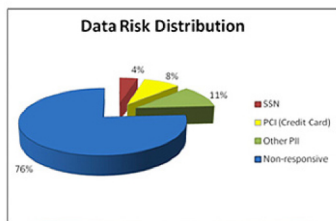

LAN Control with Crestron RoomView®, PJ-Link and AMX

LAN Control is designed to help IT managers perform day-to-day projector maintenance and repair tasks efficiently and effectively offering them full access and control over every projector directly from their workstations. The MX726/MW727 offers seamless support for the Crestron RoomView and PJ-Link LAN Control system.

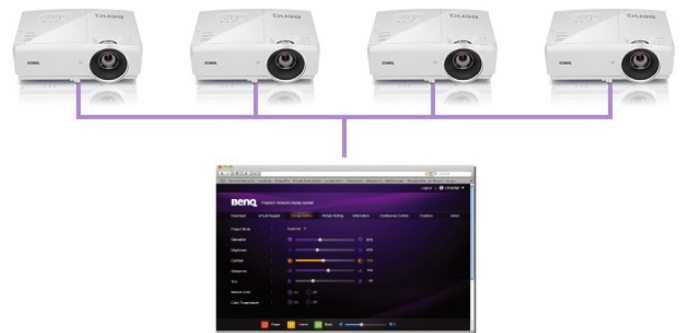

LAN Display

LAN Display offers a cost-effective solution for projector implementation management using a single LAN cable to control and display. This feature offers one NB to one projector projection display for better content management for discussions, presentations, training and classroom teaching.



Installation Flexibility

2D Keystone Correction & Corner Fit Correction

When the projector is placed off-center, the 2D keystone correction feature gives you a wider projector installation flexibility by correcting the trapezoid effect using horizontal and vertical adjustments. Moreover, corner Fit is a flexible and convenient way to correct picture dimensions by adjusting each corner of an image independently.

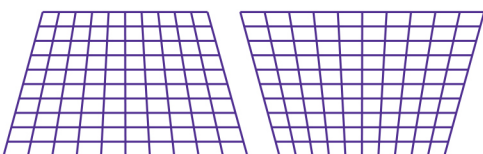

Vertical Keystone

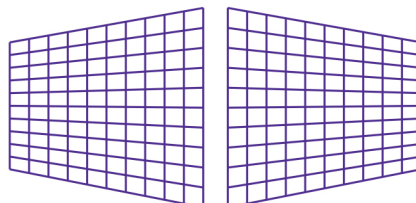

Horizontal Keystone

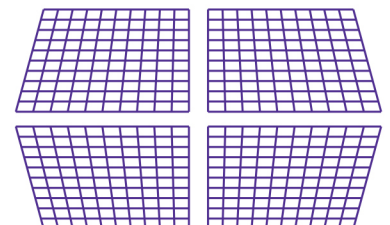

Corner Fit

Power saving, Eco Friendly

World-Leading SmartEco™ Technology for a Greener Environment

As the first DLP brand to incorporate Philips' ImageCare technology into its projector lamp system, BenQ has taken a further leap, developing its own SmartEco Technology to perfect what DLP can do for energy saving in the 21st century classroom. Built with this brand new invention, the MX726/MW727 brings together uncompromised brightness, exquisite picture quality and optimized lamp life through innovative features.



Eco Blank Mode

During breaks in presentations or when the projector is not in use, Eco Blank Mode reduces power consumption by up to 70% while at the same time eliminating distractions from the inactive screen. The blanked screen refocuses the audience's attention to the presenter while conserving energy.



Full Power On
(100% Lamp Power)



Eco Blank Mode On
(30% Lamp Power at the Lowest)

SmartEco Mode

The SmartEco Mode, which cleverly adjusts the lamp power to maximize power saving by delivering the best contrast and brightness performance using only as much light as needed.



Normal Mode
296W Projector Power
Consumption by Average



SmartEco Mode
Enhanced Details in Darkened Scenes
163W Projector Power Consumption by
Average

(Source: 2010 Philips white paper)

No Source Detected Mode

The automatic switch to Eco Blank Mode after the projector is turned on for over three minutes without a display source, eliminating unnecessary energy waste and prolonging the life of the projector lamp.



Source Detected
100% Lamp Power



No Source Detected
30% Lamp Power

Unique Features for Classrooms

Built-in 10W Speaker Power

The MX726/MW727 comes with enhanced audio support for your classroom, delivering crisp-clear audio performance with built-in 10W speaker power. Now, teachers can teach with ease and students can learn more effectively.



Microphone Input Support

With the microphone input, teachers get to reach every student with straining their voice. All they need to do is plug in the microphone or microphone headset to get started! The built-in speaker will do the rest!



Thoughtful Teaching Template Design

To make your teaching job easier, BenQ has added the teaching template function to the MX726/MW727. Now, with three different line pattern designs to choose from – Letter Formation, Worksheet and Coordinate Chart, you can easily write or draw on whiteboards as well as blackboards without the need of drawing lines or charts.

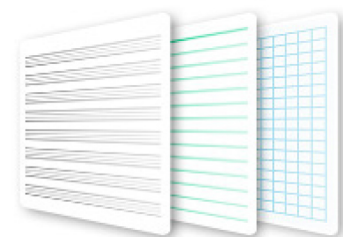

Dimension

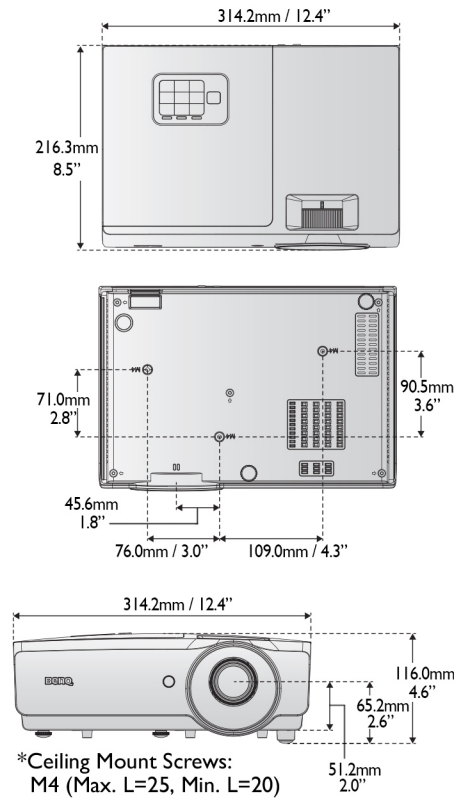

Specification

	MX726	MW727
Projection System	DLP™	DLP™
Color Wheel	5 seg (RGBYW)	5 seg (RGBYW)
Native Resolution	XGA (1024x768)	WXGA (1280x800)
Brightness	4000 ANSI Lumens	4200 ANSI Lumens
Contrast Ratio	11000:1	
Display Color	1.07 Billion Colors	
Lens	F= 2.59~2.91, f=16.87~21.87mm	
Aspect Ratio	4:3	16:10
Throw Ratio	1.5-1.97:1	1.2-1.57:1
Max. Image Size (Diagonal)	300"	
Zoom Ratio	x1.3	
Lamp Wattage	280W	
Lamp(Normal/Eco Mode/SmartEco Mode)	3000h/4000h/6000h	
Keystone Adjustment	Vertical & Horizontal +/-30°	
Projection Offset	128%±5%	123%±5%
PC Signal Compatibility	up to UXGA (1600x1200)	
HDTV Compatibility	480i, 480p, 576i, 576p, 720p, 1080i, 1080p	
Video Compatibility	NTSC, PAL, SECAM	
Horizontal Frequency	15~102KHz	
Dimensions(W x H x D)	314.2 x 116 x 216.3 mm	
Weight	3.3 kg	
Audible Noise	37/34 dBA	
Power Supply	AC 100 to 240 V, 50/60 Hz	
Power Consumption	370W	
Standby power consumption	<0.5W	
Operating environment	0~40°C / 10%~90% humidity w/ no condensation	
What's in the box	carrying bag, remote control w/ battery, power cord, user manual CD, quick start guide, VGA cable, lens cover	

*Lamp life results will vary depending on environmental conditions and usage. Actual product's features and specifications are subject to change without notice.

Input and Output Terminals

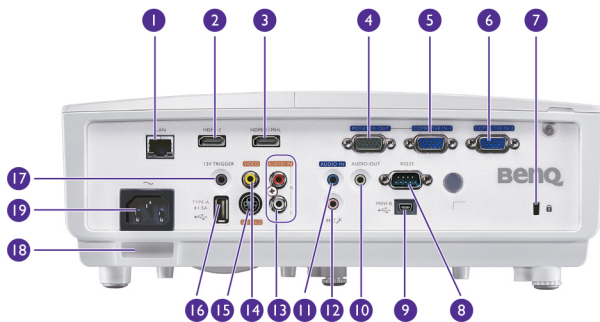

- 1- LAN (control & display)
- 2- HDMI input
- 3- HDMI input with MHL 2.0
- 4- Monitor output
- 5- Computer input
- 6- Computer input
- 7- Kensington lock
- 8- RS232 input
- 9- USB type mini B
- 10- Audio output
- 11- Audio input mini jack
- 12- Microphone input mini jack
- 13- Audio input L/R
- 14- Composite video input RCA
- 15- S-video input
- 16- USB type A
- 17- 12V trigger
- 18- Security bar
- 19- Power inlet

Optional accessory

Universal ceiling mount
- CMG1 (5J2K01.001)



Carrying Bag
- DM2 (5J2CM09.001)



Active 3D glasses
- DGD5 (5J29H25.001)



Spare lamp kit
- (5J2CM05.001)

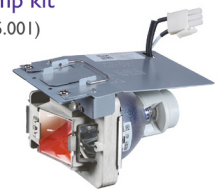

Key Features

- Horizontal & vertical keystone
- Corner fit
- Filter free design
- Compatible with PjLink
- Compatible with Crestron
- Compatible with AMX
- Compatible with Extron
- VGA signal power on
- Direct power on
- Auto power off
- Sleep timer
- Support all 3D mandatory formats
- Standby power <0.5W (network off)
- SmartEco energy saving
- Eco Blank mode
- RoHS compliant
- 2X digital zoom
- Quick auto source search
- Closed captioning
- Panel key lock
- Kensington lock
- Variable audio out
- Top access lamp door

BenQ Europe B.V.

Meerenakkerweg 1-17
5652 AR Eindhoven
The Netherlands
Tel: +31 88 888 9200
Fax: +31 88 888 9299

