



Exceptional Image Quality and Great Setup Flexibility

- High Brightness 5000AL and remarkable contrast ratio 7000:1
- Big zoom ratio and vertical lens shift provides flexible installation
- Advanced network capabilities (LAN control/LAN display/wifi display/Remote desktop)
- Easy setup: Vertical and Horizontal keystone adjustment, Corner fit, Auto input signal search, VGA signal power on, Dual HDMI, MHL connectivity
- Easy maintenance : Dust filter free design, Top access lamp door for easy lamp change
- Energy saving and environmental friendly: SmartEco, Eco blank, less than 0.5W standby power consumption(Network off), Sleep timer, Auto power off



BenQ SU917 5000AL
WUXGA DLP Projector



Because it matters

Exceptional Image Quality for High-Impact Presentations

Superior Image Quality

With 5000 ANSI lumen high brightness, the SU917 will always give you the best clarity under the brightest lights! So, take advantage! Stay in control and enjoy perfect presentations and the best interactions with your audience; moreover, the combined expertise of BenQ's projector know-hows delivers an astounding 7000:1 contrast at the highest to significantly improve the black level for superbly rendered image definition.



High Contrast



Low Contrast

Brilliant Image Performance Ultra High Resolution up to WUXGA

With up to 2.3 million pixels of resolution far surpassing 1080p, audiences can view even high-quality Full HD content in breathtaking clarity, and presenters can show more content and detail without sacrificing legibility. High resolution brings out fine details and produces more lifelike three-dimensional appearance for pictures while resolving even small text with crisp precision.

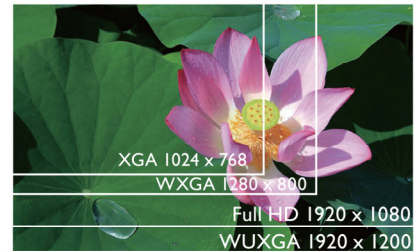

Long-Lasting DLP Image Perfection

Utilizing a nearly-sealed DLP projection engine, BenQ projectors exhibit virtually no image distortion from panel aging due to heat or dust buildup. Millions of micro mirrors on the advanced DMD chip reflect pure light through the color wheel, producing precise details and intensely saturated colors without degradation over time.



Perfect Six-Color Management via Independent 3D Calibration

Independently fine-tune the hue, gain, and saturation levels of each of the six primary colors (R/G/B/C/M/Y) with innovative BenQ 3D color management. The ability to precisely control these parameters greatly enhances mid-tones and greyscales to deliver more realistic images and video.



Installation Flexibility

Vertical Lens Shift for Precise Projector Placement

In case of any minor miscalculations to take place during the projector installation, the lens shift function can be used to adjust the position of the projected image to fit the projection screen. This adjustment can be made by using the switch next to the projector lens.



Big Zoom for Extra Projector Installation Flexibility

SU917 1.5x big zoom feature opens up space with an impressively wide range of throw distances. All you have to do is simply place the new projector right where your original ceiling mount is. Without adding projector setting re-construction costs to your budget list, you'll get to save the money for better use.



2D Keystone Correction & Corner Fit Correction

When the projector is placed off center, the 2D keystone correction feature gives you a wider projector installation flexibility by correcting the trapezoid effect using horizontal and vertical adjustments. Moreover, corner fit is a flexible and convenient way to correct picture dimensions by adjusting each corner of an image independently.

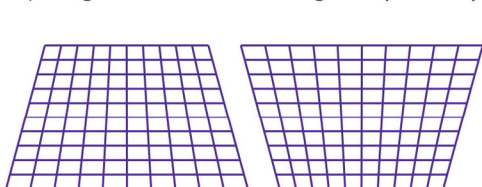

Vertical Keystone

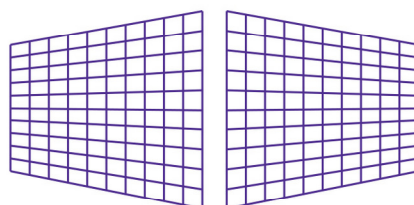

Horizontal Keystone

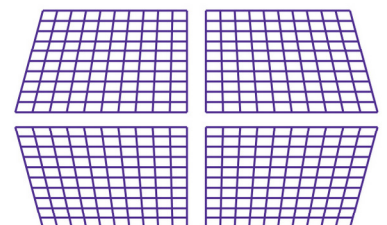

Corner Fit

Complete Remote Control and Easy Maintenance

LAN-Based Multiple Projector Management (AMX/CRESTRON/PJ-Link/Extron)

Projector monitoring, scheduling, and management are under convenient IT manager control utilizing BenQ's intuitive interface. Compatible with PJ-Link, Crestron, and AMX control systems for convenient system integration with multiple third-party A/V components, BenQ High Brightness projectors allow remote operation and status supervision over multiple remote projectors to minimize labor cost and resources.



Dust Filter Free Design

BenQ Projectors feature leading-edge Digital Light Processing (DLP) Technology, featuring nearly-sealed projection engines able to deliver persistent picture perfection without the hassles and costs of filters. The ability of DLP to keep heat and dust out of the engine results in long-lasting clarity without unnecessary filter replacement and cost.



World-Leading SmartEco™ Technology for a Greener Environment

As the first DLP brand to incorporate Philips' ImageCare technology into its projector lamp system, BenQ has taken a further leap, developing its own SmartEco™ Technology to perfect what DLP can do for energy saving in the 21st century classroom. Built with this brand new invention, the SU917 brings together uncompromised brightness innovative features.



Convenient Lamp Access

Top-mounted quick-release doors for lamp replacement eliminate the need to move the projector for quick, hassle-free lamp exchange. This versatility prevents the need to remove the projector from its mounting bracket in single or multiple projector installations for lamp replacement.



Eco Blank Mode

During breaks in presentations or when the projector is not in use, Eco Blank Mode reduces power consumption by up to 70% while at the same time eliminating distractions from the inactive screen. The blanked screen refocuses the audience's attention to the presenter while conserving energy.



Connectivity

Advanced Connectivity

- 2x HDMI
 - it allows for simultaneous digital connection of high-definition A/V devices
- MHL
 - it enables you to output video from your Android MHL-enabled smartphones or tablets, turn your projector into a smart display.
- Display PC content over wired and wireless network
 - QPresenter PC software provides content streaming from PC to projector via network.
- USB reader
 - To read the file from USB memory devices with GIF, TIFF, PNG and BMP file format supported
- USB display
 - Mirroring display your computer by connecting a USB cable from to projector without installing any drivers



LAN Display: Ultra-Smooth Signal for Simultaneous Image Display

LAN Display offers a cost-effective solution for projector implementation management using a single LAN cable to control and display. This feature offers one NB to one projector projection display for better content management for discussions, presentations, training and classroom teaching.

Benefit Highlights

- Easy installation with one LAN cable for control and display
- Partial projection display option for easy content management
- Simultaneous image display support of up to 8 projectors for special events
- 4-to-1 display convenience for meeting discussions and presentations



Dimension

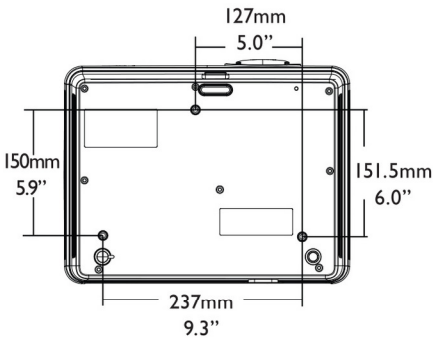
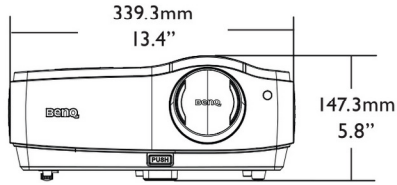
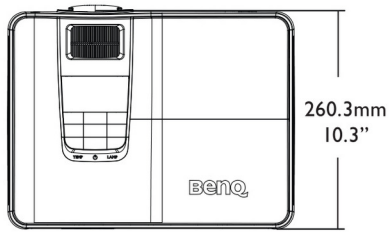

Specification

Projection System	DLP
Native Resolution	WUXGA (1920x1200)
Brightness*	5,000 ANSI Lumen
Contrast Ratio	7,000:1
Display Color	1.07 Billion Colors
Lens	F=2.42~2.95, f=20.77~31.13mm
Aspect Ratio	Native 16:10 (5 aspect ratio selectable)
Throw Ratio	1.37 - 2.05
Image Size (Diagonal)	40" ~ 300"
Zoom Ratio	1.5x
Lamp Type	340W
Lamp(Normal/Economic Mode/SmartEco Mode)*	2300/3000/3500 hours
Keystone Adjustment	Vertical & Horizontal ± 30 degrees
Projection Offset	Vertical lens shift 120-145%
PC Signal Compatibility	VGA (640 x 480) to WUXGA_RB(1920 x 1200) *RB = Reduced blanking
HDTV Compatibility	480i, 480p, 576i, 576p, 720p, 1080i, 1080p
Video Compatibility	NTSC, PAL, SECAM
Dimensions(W x H x D)	339.3x147.3x260.3mm (1.36x5.8x10.2 inches)
Weight	3.7Kg (8.16 lbs)
Audible Noise	36/34 dBA (Normal/Economic mode)
Power Supply	AC100 to 240V, 50 to 60 Hz
Power Consumption	390W (lamp normal mode), 330W (lamp eco mode) Standby<6.0W (network on), Standby<0.5W (network off)
Operating environment	Operating temperature 0°C-40°C Operating humidity 10%-90% (no condensation)
What's in the box	SU917 Projector, power cord, remote control batteries, VGA cable, Quick start guide, User manual CD

Input and Output Terminals

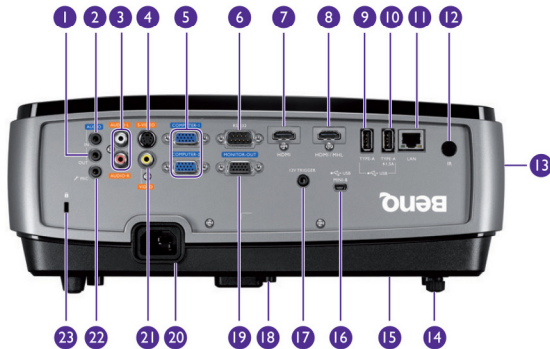

- | | |
|--|--|
| <ul style="list-style-type: none"> ① Audio output jack ② Audio input jack ③ Audio (L/R) input jack ④ S-Video input jack ⑤ RGB (PC)/Component video (YPbPr/YCbCr) signal input jack ⑥ RS-232 control port ⑦ HDMI input jack ⑧ HDMI/MHL input jack ⑨ USB type A jack ⑩ USB type A/1.5A jack ⑪ RJ45 LAN input jack | <ul style="list-style-type: none"> ⑫ Rear IR remote sensor ⑬ Ventilation holes (exhaust) ⑭ Rear adjuster foot ⑮ Ceiling mount holes ⑯ USB mini-B jack ⑰ 12V DC output terminal ⑱ Quick-release adjuster foot ⑲ RGB signal output jack ⑳ AC power cord inlet ㉑ Video input jack ㉒ Microphone input jack ㉓ Kensington anti-theft lock slot |
|--|--|

Optional accessory

Universal ceiling mount
- CM00G3 (5J.JAM10.001)



Quick wireless connection kit
- WDS01 (5J.J9P28.E01)



Active 3D glasses
- DGD5 (5J.J9H25.001)



Spare lamp kit
- (5J.JCT05.001)



Carry bag
- (5J.J2V09.011)



Key Features

- | | | | | |
|--|---|---|---|---|
| <ul style="list-style-type: none"> - Horizontal & Vertical keystone - Compatible with PJLink - Direct power on/off - SmartEco energy saving - Closed captioning | <ul style="list-style-type: none"> - Corner fit - Compatible with Crestron - Sleep timer - Eco Blank mode - Panel key lock | <ul style="list-style-type: none"> - Vertical lens shift - Compatible with AMX - Support all 3D mandatory formats - RoHS compliant - Kensington lock | <ul style="list-style-type: none"> - 1.5X flexible zoom - Remote desktop - Standby power <0.5W (network off) - 2X digital zoom - Variable audio out | <ul style="list-style-type: none"> - Filter free design - VGA signal power on - Quick auto source search - Top access lamp door |
|--|---|---|---|---|

BenQ Europe B.V.

Meerenakkerweg 1-17
5652 AR Eindhoven
The Netherlands
Tel: +31 88 888 9200
Fax: +31 88 888 9299



Because it matters